

Data Sheet



Article number: 03556070

Description: Fluro hydraulic rod end FS 70N

Measures

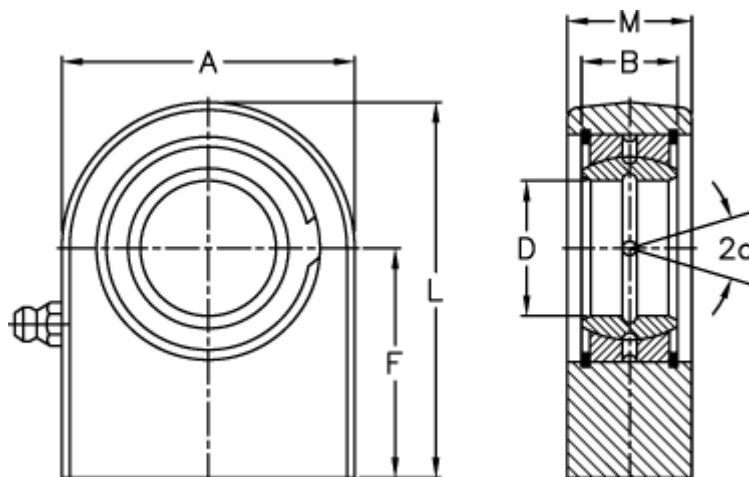

A	= 164	Static load C0 (kN) = 695
a (degrees)	= 6	Weight = 10700
B	= 49	
D	= 70	
Dynamic load C (kN)	= 315	
F	= 115	
L	= 197	
M	= 55	